



SYSTEM **KAN-therm**

Surface heating

Comfort and efficiency



TECHNOLOGY OF SUCCESS



ISO 9001

Contents

7 **KAN-therm** system surface heating

Basic information	226
Thermal comfort	227
System KAN-therm surface heating - elements	228
Pipes	228
Edge and damp-proof insulation	229
Thermal insulation	229
Heating plate design	230
Manifolds	231
Mixing systems	232
Installation cabinets	233
Design of floor heaters - pipe fastening system	234
Execution of floor screed	239
Assembly	240
Construction of wall heaters - pipe fastening systems	241
Installation of wall heating using wet method	242
Automatic control of heating/cooling systems	244
Terminal blocks Basic	245
Room thermostats Basic	246
Week thermostats Basic	247
The additional elements Basic	247
Basic+ automation	248
Basic+ thermostats	249
Additional elements Basic+	250
SMART automatics	251
Automation additional elements	255
Surface heating/cooling of KAN-therm System - assortment	257
Floor Heating - Tubes and equipment for pipe	259
Tacker - pipe fastening system	261
Rail - pipe fastening system	262
Profil - pipe fastening system	262
TBS - pipe fastening system	263
NET - pipe fastening system	264
Underfloor heating accessories	265
Manifolds and accessories for manifoldsy	266
Underfloor heating cabinets	274
Basic - automatics	275
Basic+ - automatics	277
Smart - automatics	278
Additional accessories	279

KAN-therm WALL

Wall heating



SYSTEM
KAN-therm

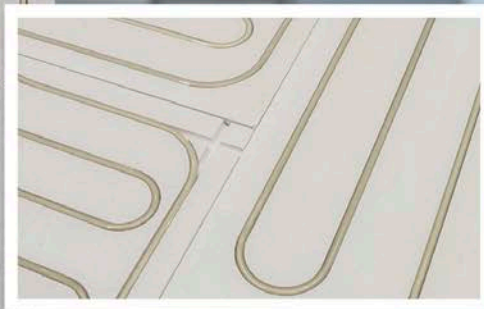

Wall heating in dry method



Wall heating in wet method

- **Comfortable** - the effect of the radiating walls, temperature distribution close to optimum.
- **Practical** - possibility of free shaping of heated/cooled room - heating/cooling is supplied where you are.
- **Economic** - heating energy saving - possibility of reducing seasonal wear of thermal energy in comparison with radiator heating.
- **Clean** - clean surfaces, using the wall heating system eliminates dust flow.
- **Permanent** - system operating life exceeds 50 years.
- **Secure** - low temperature of the heating element is applied, the product has a 10-year warranty and is insured for PLN 30 million.
- **Fast and easy** to install.

TECHNOLOGY OF SUCCESS



www.kan-therm.com

ISO 9001

KAN-therm SYSTEM



BASIC+

Wired automatic control



New look for wired automatic control

- Large area handling — strips available up to 10 zones
- Up to 18 servomotors can be connected
- Flexible investment configuration — 5 servomotors can be connected to one zone
- Changeable for NC or NO servomotors
- Pump and boiler control
- Elegant design, ideally fits to modern interiors
- Simple thermostat handling

TECHNOLOGY OF SUCCESS



www.kan-therm.com

ISO 9001

KAN-therm SYSTEM

New in surface heating



SYSTEM
KAN-therm

CHOOSE WISE
Choose stainless steel!



Stainless manifolds for surface heating

Completely new stainless manifolds dedicated for underfloor heating, wall and ceiling heating.

Stainless steel ensures greater durability of use. When compared to typical brass manifolds on 1 inch profiles, the stainless steel manifolds allows **for more than 1,5 times greater flow**.

- Stainless beam with 1 1/4" profile with female thread 1"
- 3/4" nipples with 50 mm span for easy and a secure connection with pipes by Eurocone adapters
- Valves for electric servomotors with M30x1.5 thread
- Material resistant to glycol mixtures up to 50%
- With or without a drain-bleed section
- Clear indication of beams for easy installation
- The rubber insert damping vibration ensures quiet operation
- Resistance to 6 bar and 70°C
- More than 1,5 times greater flow when compared to typical brass manifolds

KAN-therm Tracker system

New, universal tacker for clips

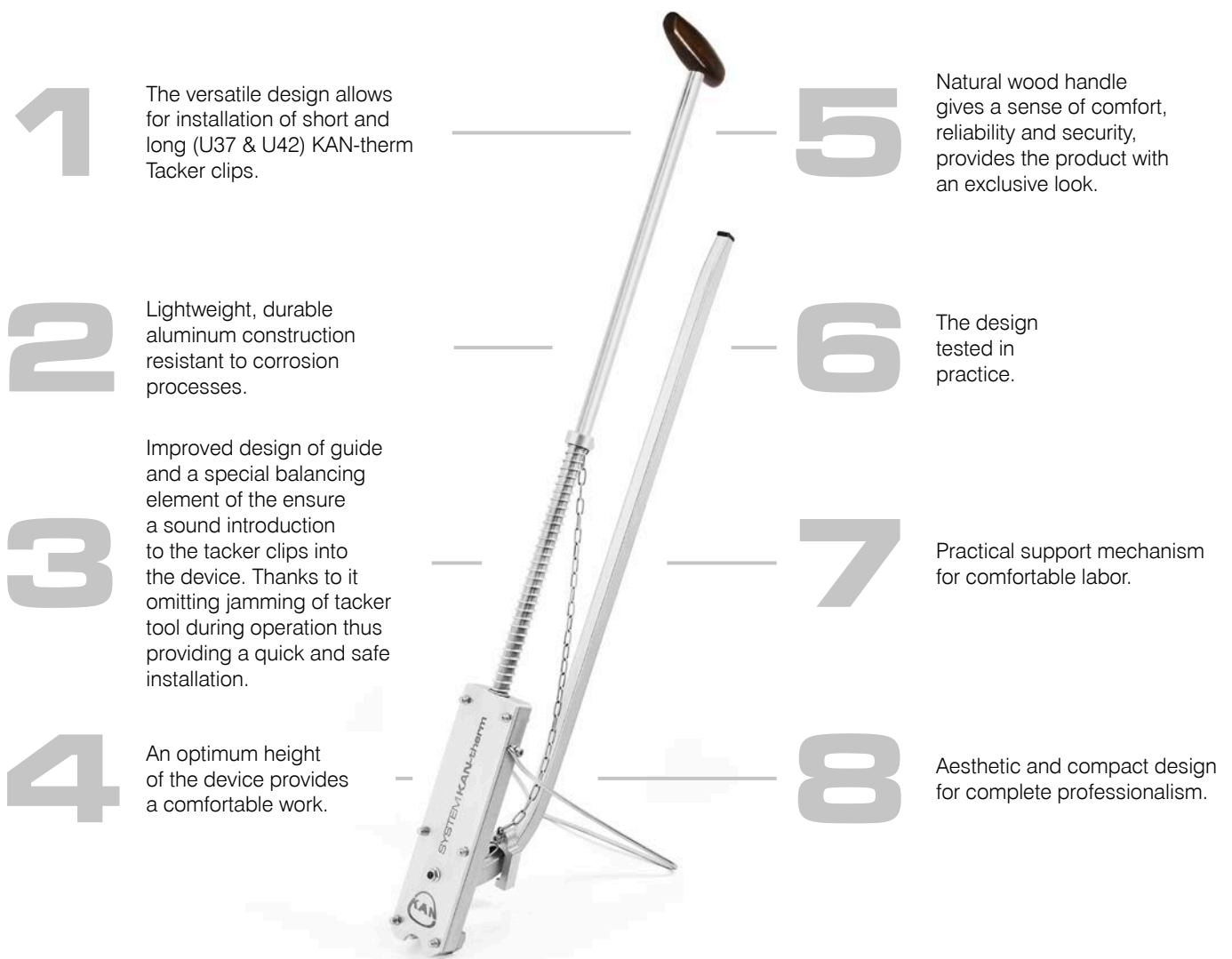

1 The versatile design allows for installation of short and long (U37 & U42) KAN-therm Tacker clips.

2 Lightweight, durable aluminum construction resistant to corrosion processes.

3 Improved design of guide and a special balancing element of the ensure a sound introduction to the tacker clips into the device. Thanks to it omitting jamming of tacker tool during operation thus providing a quick and safe installation.

4 An optimum height of the device provides a comfortable work.

5 Natural wood handle gives a sense of comfort, reliability and security, provides the product with an exclusive look.

6 The design tested in practice.

7 Practical support mechanism for comfortable labor.

8 Aesthetic and compact design for complete professionalism.

New clip

New stacking quality for surface heating

- Increased range of supported diameters, even up to 20 mm,
- Cheap packaging and handy clip sets,
- Proven on a difficult and demanding German market,
- The product recommended by German installers.



TECHNOLOGY OF SUCCESS



7 KAN-therm system surface heating

The KAN Company, manufacturer of the KAN-therm systems for many years promotes modern and user-friendly surface heating installations. The design of a System KAN-therm surface heating is very simple. Thanks to a rich selection of design solutions, wide assortment of system elements (manifolds, installation cabinets and automation elements) you can precisely select a heating system depending on the local conditions.

Among surface heating systems we offer:

- heating of surfaces in contact with open air (sports field pitches, stadium pitches, transport routes, garage drives/ramps, external stairs and terraces),
- floor, ceiling and wall type heating inside buildings.

For heating inside buildings different designs of surface heaters can be chosen depending on construction conditions, the use of a building etc:

- sports halls with elastic floors,
- wooden structure floors with an air void,
- poured structures of a floor heating – laid by a so-called wet method,
- structures of a floor heating laid by a dry method – especially useful for an overhaul or adaptation of buildings,
- structures of wall heating laid by wet method,
- structures of wall heating laid by dry method - especially useful for an overhaul or adaptation of buildings, as well as rooms with irregular shapes (e.g. attics).

Advantages of a System KAN-therm floor heating:

- best temperature distribution in a room,
- energy saving,
- possible cooperation with cost-effective heat sources, e.g. heat pumps and condensing boilers,
- maximum use of the space surface,
- system friendly for allergists,
- in summer the system can cool spaces,
- high quality and reliability,
- competitive price,
- fast and easy assembly,
- rich selection of system designs,
- quiet run, no vibration,
- resistance against corrosion
- materials do not cover in limestone,
- environment friendly materials..

The KAN Company supplies also computer programmes aiding to design floor heating systems:

- **KAN co-Graf** for designing heating systems with an option for designing a floor heating,
- **KAN Quick Floor** an Internet programme for a quick calculation of a floor heating based on the EN 1264 standard with an option of listing materials,
- **KAN ozc**, as an addition for calculating heat losses in buildings and individual spaces,
- **KAN SDG** is a programme for quick selection of floor heating and convection heaters, with an option to approximately calculate rooms design heat load.

All programmes are available at www.kan-therm.com

Basic information

The wall heating involves installation of heating pipes in the inner vertical layers of construction partitions. This can be achieved in two ways - by fixing the heating pipes to the construction layer and covering with plaster (wet method) or by finishing the inner surface of the walls with plasteboards with embedded heating pipes (dry method). Heating of this type not only provides optimum thermal comfort but also reduces heat loss from the room (transmission of heat from the warmer to the colder place through the partition of a higher temperature is physically impossible). Heating of this type is ideal for use in rooms with sloping walls (attics) which are difficult to arrange.

Wall heating:

1. laid using wet method - pipes covered with plaster.
2. laid with dry method - pipes embedded in gypsum fibre boards.

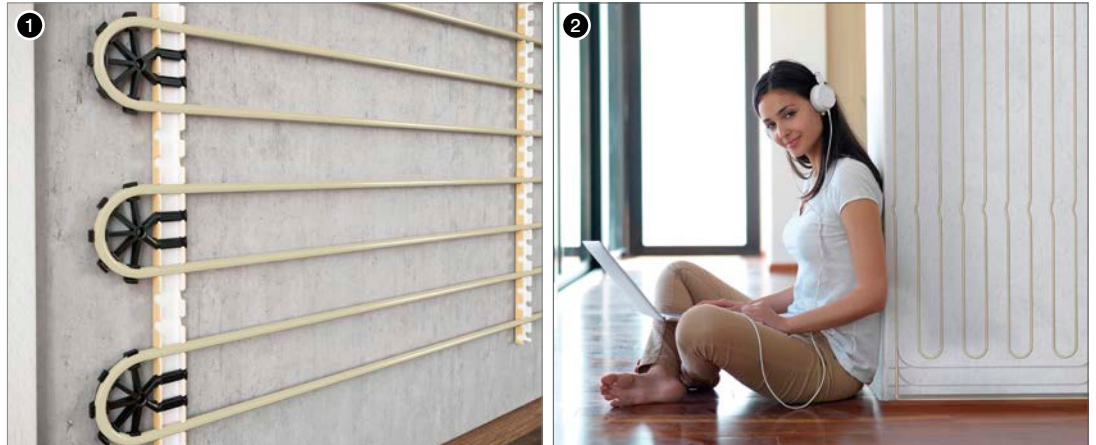

A floor heating is directly immersed in a poured on layer of screed (floor leveller). Thus a heater is made, which in fact is a floor itself.

This kind of heating is very popular and can be successfully used in one-family houses and high standard apartment buildings.

The floor heating system has turned out to be the best solution to maintain the best warmth comfort in the building industry, e.g:

- churches,
- public buildings (sports halls, exhibition halls),
- industrial buildings.

Wet laid floor heating – pipes embedded in a cast screed



Thermal comfort

Surface heating is a heating system, where the most of the heat is given up by radiation. The heat flux is conducted by the pipe, then thru the concrete layer as the heating plate, and next thru the flooring and is given up to the environment.

The floor temperature is raised thus it is not a cold barrier (does not cool feet) and does not negatively affect the wind chill (the resultant of the air temperature, wall temperature and floor temperature in a room), which decides on the warmth comfort.

Therefore the air temperature in a room of 20°C provides the same thermal comfort as 21°C - 22°C, achieved with traditional heaters and convectors. The human body does not feel variations of the room temperature by 1°C.

With the floor and wall heating a heat distribution almost ideal for the human is achieved.

What's important with a surface heating is the reduced air convection as compared to radiators (convection type), which can raise dust.

Vertical distribution of temperature for various types of heating

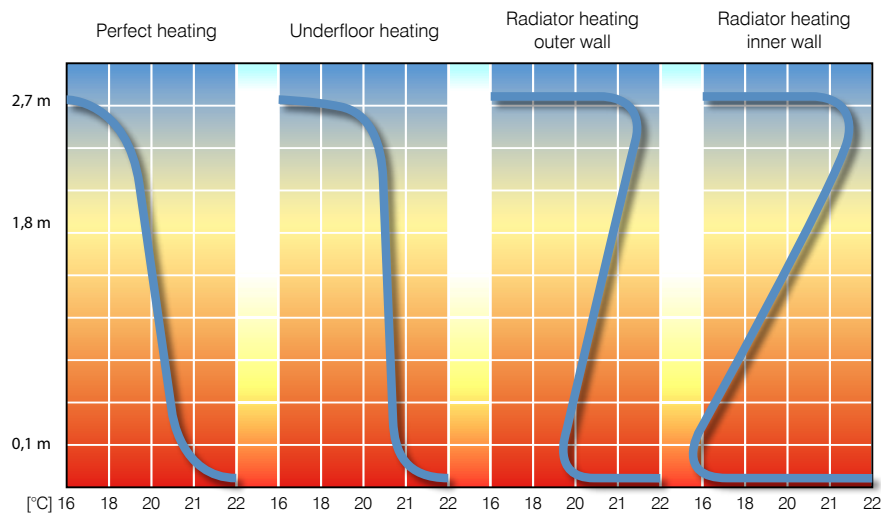

System KAN-therm surface heating - elements

1. Heating pipes.
2. Edge insulation.
3. Thermal insulation and damp insulation
4. Distributor for floor heating
5. Installation cabinet.
6. Temperature regulator

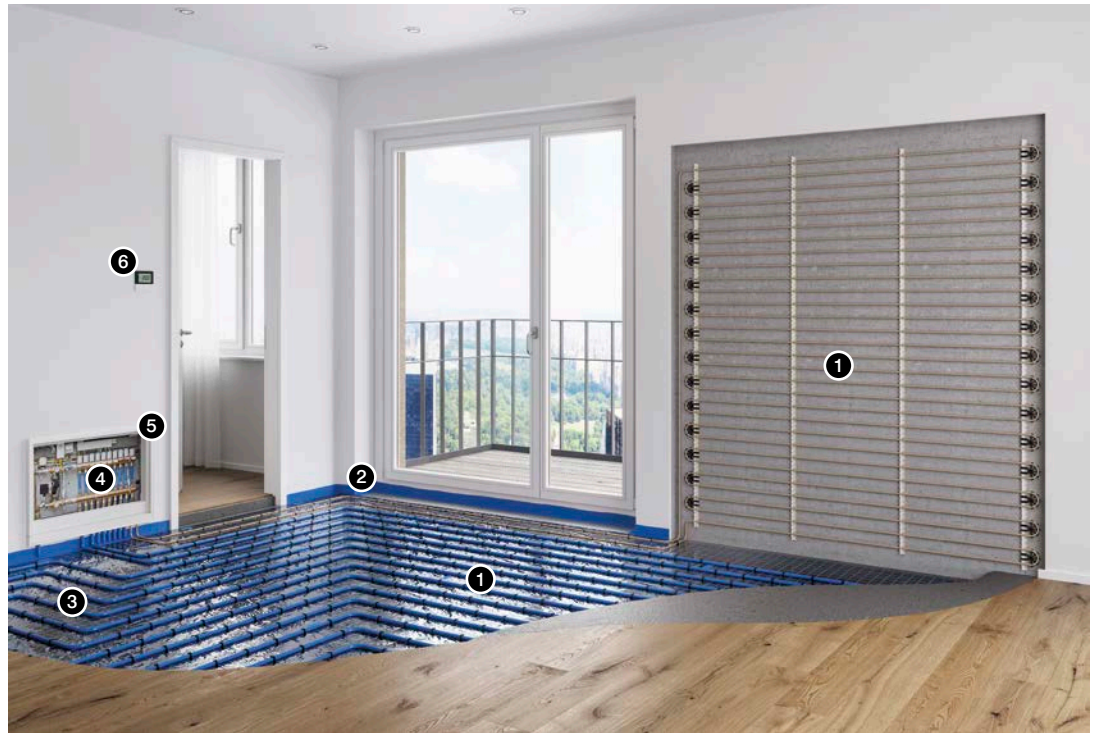

Pipes

Plastic pipes laid and fixed to Styrofoam sheets are the heating element of the System KAN-therm.

The KAN-therm System for floor and wall heating offers a very wide assortment of pipes both in terms of diameters and types. This allows selecting a best technical and cost-effective solution to satisfy all customers' requirements.

For construction of a KAN-therm floor heating two kinds of plastic pipes can be used: PE-Xc and PE-RT with an antidiffusion barrier or multi-layer PE-RT/Al/PE-RT pipes with an aluminum insert. Depending on the required heat capacity of a floor heating system we use pipes of a diameter between Ø12 and 26 mm. For wall heating system we use Ø8 – 16 mm pipes covered with a special plaster or in finished panels mounted on the wall.

Pipes are available in coils 100-600 m depending on the pipe diameter. The use of pipe decoiler Uncoiling pipes from coils 600 m allows you to form heating coils fast and easy without turning them around their axis. Turning pipes around their axis causes tensions and a tendency of a pipe to separate from a substrate therefore forces to make it fast to the substrate must be greater.

1. Pipe in coil
2. Decoiler for pipe coils
3. uncoiler guide



Edge and damp-proof insulation

Materials for damp proof insulation:

- PE foil in rolls,
- metalized or laminated foil on Tacker plates,
- PS-foil on Profil plates.

Edge insulation:

- reduces heat losses through walls;
- constitutes dilatation of concrete heating panel from outer walls and structural components,
- laid up to concrete layer high (in case of ceramic floor covering, also ceramic covering should has dilatation from walls and structural components).

Materials of edge insulation:

1. Wall tape with incision
2. Wall tape with incision and apron
3. Expansion joint profile with feet.



Thermal insulation

Requirements for thermal insulation to PN-EN 1264:

- $R = 0,75$ [m^2K/W] – required insulation thermal resistance above a heated space,
- $R = 1,25$ [m^2K/W] – required insulation thermal resistance above a not heated space or on the ground ($T_z \geq 0$ °C),
- $R = 2,00$ [m^2K/W] – required insulation thermal resistance on the ground (-5 °C $\geq T_z \geq -15$ °C).

Material for thermal insulation:

- Styrofoam sheets Tacker with a metalised or laminated foil 20, 30, 35 and 50 mm thick,
- Styrofoam sheets Profil – 2 and 4 thickness 11 and 30 mm,
- Styrofoam sheets TBS – thickness 25 mm.

When you lay Styrofoam on a bitumen substrate use a separating PE-foil.

Heating plate design

1. Wall
2. Plaster layer
3. Plinth made of tiles
4. Expansion joint
5. Sports floor covering
 - 5a. Fibre glass coating
 - 5b. Elastic layer 10 mm
6. Screed
7. Pipe clip
8. KAN-therm heating pipe
9. Wall tape with PE protective cover
10. KAN-therm Tacker system board, thickness A, with metallized or laminate film
11. Damp insulation (only at ground level!)
12. Concrete ceiling

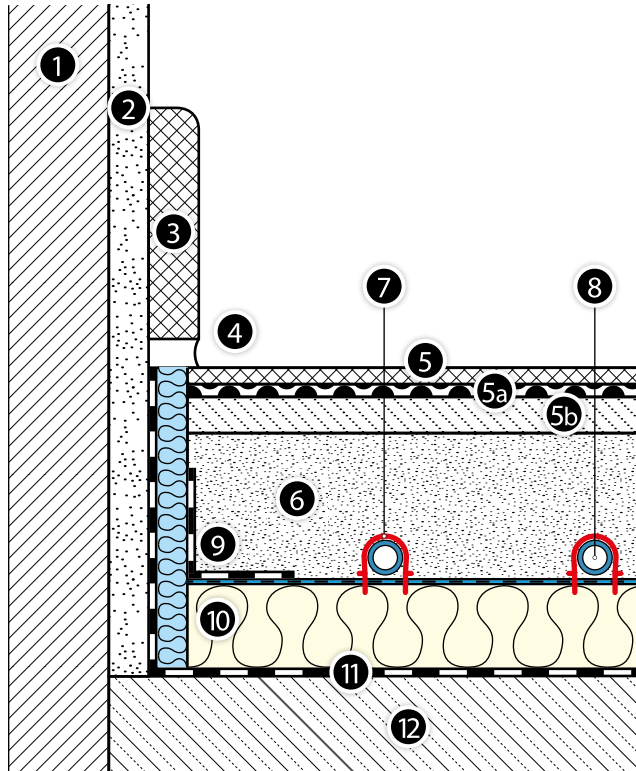

1. Wallcovering (wallpaper, ceramic tiles)
2. Plaster
3. Mounting mesh 7x7 mm
4. KAN-therm heating pipe
5. Mounting rail
6. Dowel
7. Wall construction
8. Thermal insulation
9. External plaster
10. Expansion joints

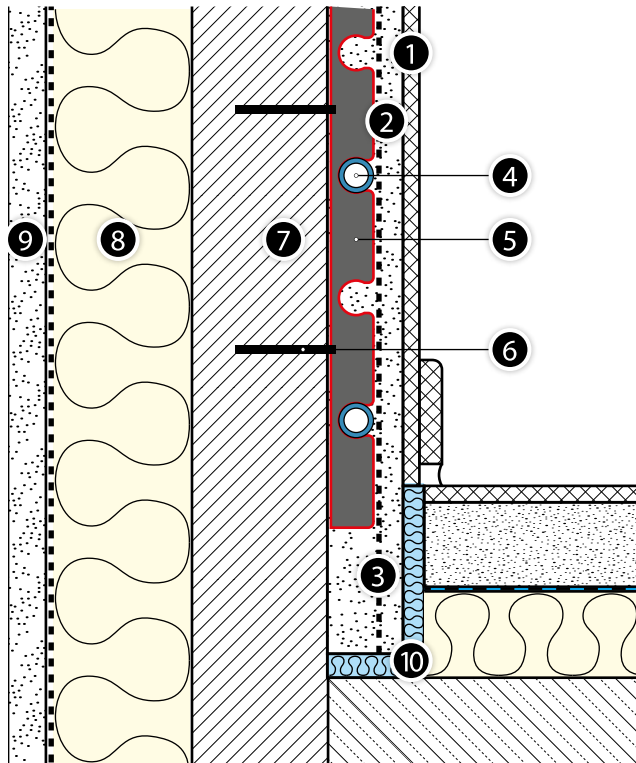

For detailed requirements for heating plates (screeds) see instructions delivered by KAN company.

Manifolds

The basic adjustment of a floor heating consists in equalisation of flow resistance thru individual loops to ensure an even water flow distribution.

This regulation can be done with:

- regulation valves on their lower beam of 51A and 71A manifolds,
- regulation and measuring valves (flow meters) on the bottom beam of 55A and 75A series manifolds N75A and N75E.



Manifold series N75A



Manifold series N75E



Manifold series 51A



Manifold series 71A



Manifold series 55A



Manifold series 75A

Mixing systems

Surface heating is a system operating on low parameters. The max supply temperature shall not exceed 55°C. Therefore in case of supplying a surface heating from the same source as traditional radiators local or central mixing sets shall be used:

Central mixing sets: are used in case a surface heating is planned on a number of building stories. These sets are usually installed in a boiler room, close to a boiler.

— with automatic control,

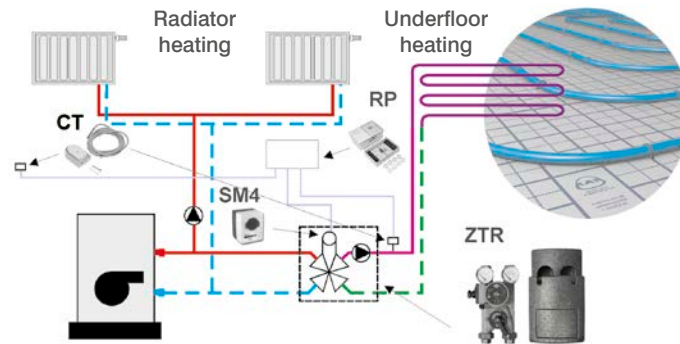

A KAN Bloc (ZTR) mixer provided additionally with an servomotor, weather regulator (RP) and temperature sensors adjusts the system automatically, e.g. as a function of the external temperature.

— with semi-automatic control.

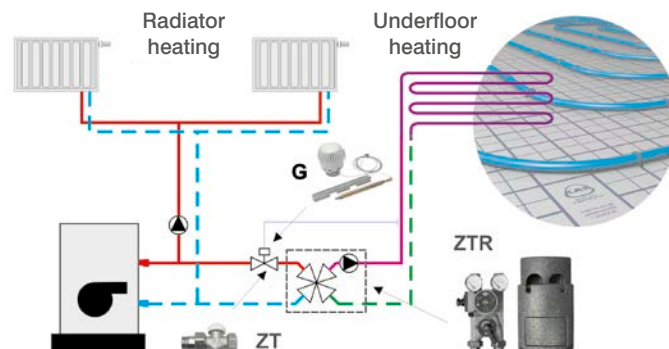

A KAN Bloc (ZTR) mixer with a 4-way valve provided additionally with a thermostatic valve (ZT), adjusts a system semi-automatically.

Local mixing units: are used in case a surface heating is planned within one storey. These sets shall be installed in installation cabinets, close that a heating installation cabinets, near the underfloor heating system.

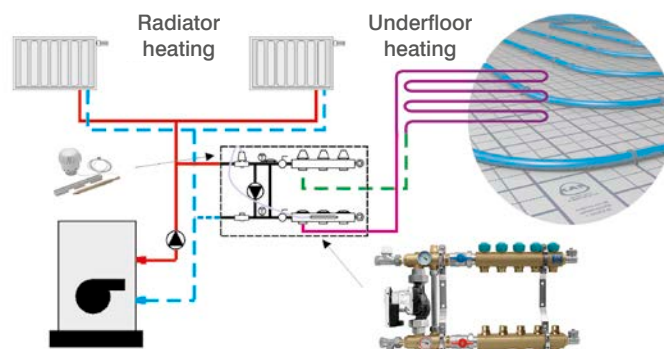

A 73E and 77E series manifold connected directly to a heating system operates as a local mixing system. A thermostatic head with a capillary tube serves as a protection against a possible temperature rise. It can be adjusted "down" from 55°C.

Caution! do not use with low temperature heat sources.

Installation cabinets

Manifolds for surface heating shall be mounted in special installation cabinets available in three versions: surface –mounted, embedded and clad with glazed tiles.



Due to the design of cabinets for floor heating manifolds can be mounted with or without a mixing device. In cabinets there is also room for electrical terminal blocks. Terminal blocks are attached by screws, which enter into special holes in a mounting strip in the upper part of a box.

The Table 1 below allows a fast selection of cabinets depending on the manifold type, basic equipment and the way of connection.

Tab. 1 Selection of installation cabinets for floor heating depending on the type of manifold and basic equipment

Cabinet type	Code	Height [mm]	Width [mm]	Depth [mm]	Number of circuits		
					OP Manifold	OP + Set-P/ Set-K Manifold	Manifold OP with a mixing system*
SWN-OP – 10/3	1446180000	710	580	140	2-10	2-7/2-6	2-3
SWN-OP – 13/7	1446180001	710	780	140	11-13	8-11/7-10	4-7
SWN-OP – 15/10	1446180002	710	930	140	14-15	12-14/11-13	8-10
SWPG-OP – 10/3	1446117002	570	580	110-165	2-10	2-7/2-6	2-3
SWPG-OP – 13/7	1446117001	570	780	110-165	11-13	8-11/7-10	4-7
SWPG-OP – 15/10	1446117000	570	930	110-165	14-15	12-14/11-13	8-10
SWP-OP – 10/3	1446117003	750-850	580	110-165	2-10	2-7/2-6	2-3
SWP-OP – 13/7	1446117004	750-850	780	110-165	11-13	8-11/7-10	4-7
SWP-OP – 15/10	1446117005	750-850	930	110-165	14-15	12-14/11-13	8-10

* Required depth of cabinet: 140 mm

OP manifold – manifold series 51A, 55A, 71A and 75A for floor heating,

OP + Set-P/Set-K manifold – manifold series 51A, 55A, 71A and 75A for floor heating with Set-K angle valves or straight valves type Set-P (2-7/2-6 – number of circuits with Set-K valves/ number of circuits with Set-P valves),

OP manifold with a mixing unit – manifold series 73E and 77E with a mixing unit.

Design of floor heaters - pipe fastening system

System KAN-therm Tacker

System KAN-therm delivers insulation plates with a metalised or laminated plate with an overprint every 5 cm.

- Use plates Tacker EPS 100 038 (PS20) for standard floor slab loads up to 3.5 kN/m² in residential or office buildings,
- Plates Tacker EPS 200 036 (PS30) shall be used for higher floor slab loads up to 5.0 kN/m², e.g. conference rooms or lecture rooms,
- Tacker EPS T-30 dB plates shall be used in sound-proof rooms; e.g. recording studios.



The foil glued onto plates serves as a damp proof insulation to DIN 18560 and can be overlapped, thus plates can be laid tight.

To seal places, where plates join, use adhesive tape dispensed from a hand feeder.

Pipes are fixed to Tacker plates with clips driven with a tacker tool. For 20 mm thick Styrofoam plates use short clips driven with a tacker tool for short clips.



Thanks to an overprinted grid it is easy to lay pipes at a determined spacing. You can use Ø14×2, 16×2, 18×2, 20×2 mm pipes spaced every 10-30 cm.

Pipes can be fastened to Styrofoam sheets of the Tacker type also using mounting rails provided with an adhesive tape or with NET nets with clamps (see: System KAN-therm Rail and NET).

When laying Tacker plates with a foil observe requirements from the EN 1264 standard regarding the minimum heat resistance of a floor-ceiling assembly with the floor heating. In case of floors on the ground and floor slabs in contact with atmospheric air under the EPS system plates there should be an additional insulation. For requirements and versions of using multi-layer system plates type EPS with an additional foil see Table 2.

Tab.2 System KAN-therm Tacker – Minimum requirements for insulation according to EN 1264 standard

Required insulation thickness above a heated room $R=0,75$ [m^2K/W] (PN-EN 1264)			
Floor heating system	Additional insulation	Insulation resistance	Insulation thickness [mm]
System Tacker 30 mm	-	$R=0,775$	30
System Tacker 20 mm	foamed polystyrene EPS100 (PS20) 20 mm	$R=0,875$	40
Required insulation thickness above an unheated room or on the ground ($T_z \geq 0$ °C) $R=1,25$ [m^2K/W] (PN-EN 1264)			
Floor heating system	Additional insulation	Insulation resistance	Insulation thickness [mm]
System Tacker 50 mm	-	$R=1,250$	50
System Tacker 30 mm	foamed polystyrene EPS100 (PS20) 20 mm	$R=1,250$	50
System Tacker 20 mm	foamed polystyrene EPS100 (PS20) 40 mm	$R=1,375$	60
Required insulation thickness in case of the contact with air (-5 °C $\geq T_z \geq -15$ °C) $R=2,00$ [m^2K/W] (PN-EN 1264)			
Floor heating system	Additional insulation	Insulation resistance	Insulation thickness [mm]
System Tacker 50 mm	foamed polystyrene EPS100 (PS20) 30 mm	$R=2,000$	80
System Tacker 30 mm	foamed polystyrene EPS100 (PS20) 50 mm	$R=2,000$	80
System Tacker 20 mm	foamed polystyrene EPS100 (PS20) 70 mm	$R=2,129$	90

System KAN-therm Profil

KAN-therm system provides Profil system plates, where pipes are attached by inserting into the shaped top part of the plate. You can use PE-Xc, PE-RT, Platinum or multilayer pipes with diameter range $\varnothing 16 \times 2$ to 18×2 mm.

Profil foamed polystyrene boards

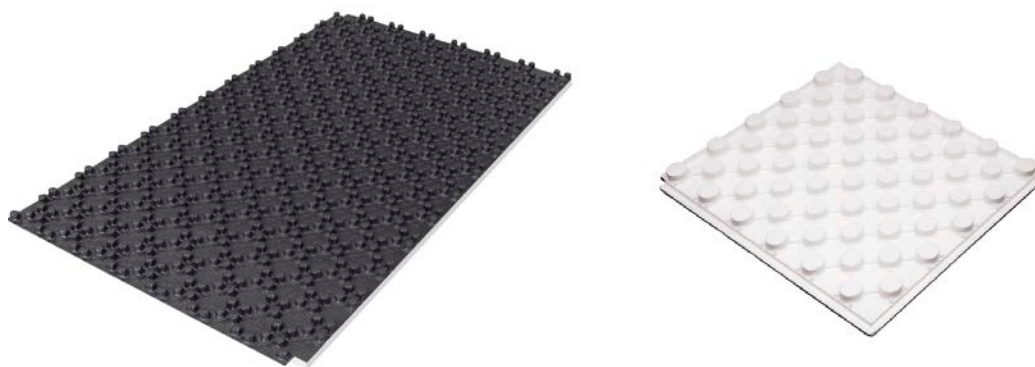

Profile foamed polystyrene boards:

- Profil1 30 mm - polystyrene foamed plates with PS foil with thickness of 30 mm and dimensions 0.84×1.44 m. Plate height with profiled part is 48 mm, and permissible load is 5.0 kN/m². Profil1 plate fulfils the requirements for ceilings between heated spaces $R=0.75$ m²/k/W.
- Profil2 11 mm - polystyrene foamed plates with PS foil with thickness of 11 mm and dimensions 0.84×1.44 m. Plate height with profiled part is 29 mm, and permissible load is 1.5 kN/m².
- Profil3 - PS foil without foamed polystyrene plate with thickness 1 mm and dimensions 0.84×1.44 m. PS plate height with profiled part is 20 mm.
- Profil4 20 mm - polystyrene foamed plates without PS foil with thickness of 20 mm and dimensions 1.2×0.6 m. PS plate height with profiled part is 43 mm.

When laying Profil1, Profil2 and Profil4 boards apply EN 1264 standard regarding minimum thermal resistance of floor with underfloor heating. Requirements and application variants of Profil boards are given in Tab. 3.

Tab. 3 KAN-therm Profil System - minimum requirements for insulation according to EN 1264 standard

Required insulation thickness above a heated room $R=0,75$ [m^2K/W] (PN-EN 1264)			
Underfloor heating system	Additional insulation	Insulation resistance	Insulation thickness [mm]
System Profil1 30 mm	-	$R=0,750$	30
System Profil2 11 mm	foamed polystyrene EPS100 (PS20) 20 mm	$R=0,810$	31
System Profil4 20 mm	foamed polystyrene EPS100 (PS20) 20 mm	$R=1,145$	40
Required insulation thickness above an unheated room or on the ground ($T_z \geq 0^\circ C$) $R=1,25$ [m^2K/W] (PN-EN 1264)			
Underfloor heating system	Additional insulation	Insulation resistance	Insulation thickness [mm]
System Profil1 30 mm	foamed polystyrene EPS100 (PS20) 20 mm	$R=1,250$	50
System Profil2 11 mm	foamed polystyrene EPS100 (PS20) 40 mm	$R=1,310$	51
System Profil4 20 mm	foamed polystyrene EPS100 (PS20) 30 mm	$R=1,395$	50
Required insulation thickness in case of the contact with air ($-5^\circ C \geq T_z \geq -15^\circ C$) $R=2,00$ [m^2K/W] (PN-EN 1264)			
Underfloor heating system	Additional insulation	Insulation resistance	Insulation thickness [mm]
System Profil1 30 mm	foamed polystyrene EPS100 (PS20) 50 mm	$R=2,000$	80
System Profil2 11 mm	foamed polystyrene EPS100 (PS20) 70 mm	$R=2,060$	81
System Profil4 20 mm	foamed polystyrene EPS100 (PS20) 60 mm	$R=2,145$	80

System KAN-therm TBS

System KAN-therm TBS underfloor heating is made using "dry" method, i.e. after laying the underfloor heating system, it is covered with dry „jointless“ floor (special floor panels).

Assembly of the system of pipe laying can take place only on totally dry and leveled floor surfaces. After laying TBS boards and pipes the system is covered with PE foil for protection and to avoid possible sounds of structure thermal movements.

Next, covering board of jointless floor 35-45 mm thick is laid. All information on covering boards (permitted loads) should be obtained from the producer of covering boards.

System KAN-therm includes:

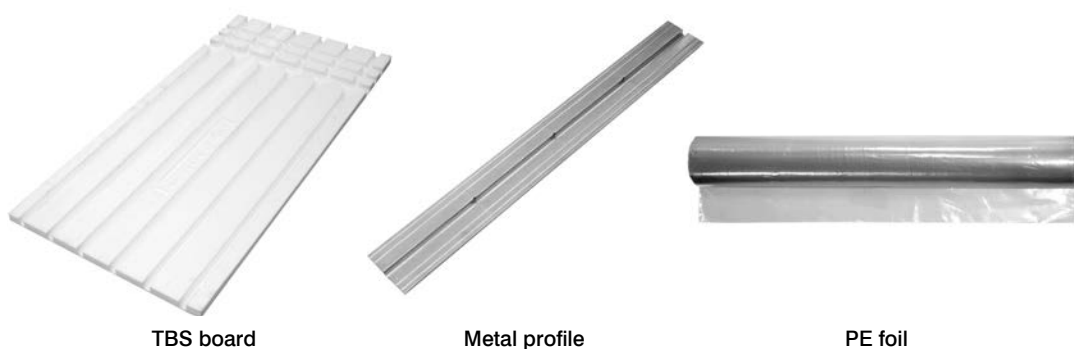

- insulation board, insulation profiled board TBS 25 mm EPS200 (PS30) with dimensions 0.5×1.0 m;
- complementary insulation board, TBS 25 mm EPS200 (PS30) with dimensions 0.5×1.0 m,
- straight metal profile TBS with dimensions 1.0×0.12 m;
- PE foil in rolls.

System KAN-therm TBS allows to lay PE-RT, PE-Xc or PE-RT/Al/PE-RT pipes of diameters $\varnothing 16 \times 2$ mm with 167 - 250 - 333 mm spacing. Because of pipe thermal expansion, straight pipe section should not be longer than 10 m and it is recommended to use PE-RT/Al/PE-RT pipes. Metal profile is pushed in laid roll formed TBS boards and then pipe is pushed in such a way that it is inside the metal profile. The metal profile has lateral incisions, which facilitates easy adjustment of its length by breaking, every 250 mm. The edge of the metal profile should end approx. 50 mm before the beginning of pipes direction change (avoiding friction of pipes against the profile as a result of thermal expansion). When laying roll formed TBS boards take into consideration planned coil shape; meander shape is recommended. Complementary insulation board TBS is used in situations when basic boards profile precludes pipes from accessing the manifold (pipe density). In such situations a required profile is cut out by a TBS cutter in complementary board.



TBS insulation cutter



TBS cutter tip

When laying TBS boards comply with requirements of EN 1264 regarding minimum thermal resistance of floor with underfloor heating. Requirements and variants of TBS boards application are given in Table 4.

Tab. 4 KAN-therm TBS System - minimum requirements for insulation according to EN 1264 standard

Required insulation thickness above a heated room $R=0,75$ [m^2K/W] (PN-EN 1264)			
Underfloor heating system	Additional insulation	Insulation resistance	Insulation thickness [mm]
System TBS 25 mm	foamed polystyrene EPS100 (PS20) 20 mm	$R=1,210$	45
Required insulation thickness above an unheated room or on the ground ($T_z \geq 0^\circ C$) $R=1,25$ [m^2K/W] (PN-EN 1264)			
System ogrzewania podłogowego	Additional insulation	Insulation resistance	Insulation thickness [mm]
System TBS 25 mm	foamed polystyrene EPS100 (PS20) 30 mm	$R=1,460$	55
Required insulation thickness in case of the contact with air ($-5^\circ C \geq T_z \geq -15^\circ C$) $R=2,00$ [m^2K/W] (PN-EN 1264)			
System ogrzewania podłogowego	Additional insulation	Insulation resistance	Insulation thickness [mm]
System TBS 25 mm	foamed polystyrene EPS100 (PS20) 60 mm	$R=2,210$	85

System KAN-therm Rail

An essential element of KAN-therm Rail System are special plastic mounting rails for pipe attachment. You can use PE-Xc, PE-RT and PE-RT/Al/PE-RT pipes with diameters $\varnothing 12 \times 2$, $\varnothing 14 \times 2$, $\varnothing 16 \times 2$, $\varnothing 18 \times 2$, $\varnothing 20 \times 2$, $\varnothing 25$, $\varnothing 26$ mm. The pipes can be laid with 10-30 cm distance - with spacing of 5 cm (for standard rails) or spacing of 10 cm (for modular mounting rail).



KAN-therm TBS system

System KAN-therm NET is a system of pipe laying on wire nets, available in the following assortment:

- PE foil 2,0 m×50 m×0,8 mm,
- 3 mm wire net 1.2 m×2.1 m and mesh spacing 150×150 mm,
- fastening bands for tying nets,
- PE fastening peg 80 mm - Ø8 mm for foil fastening,
- pipe fastening grips Ø16-18 mm and Ø20mm.

On thermal insulation made of EPS 100 038 boards or EPS 200 036 moisture insulation made of PE foil is laid and then wire nets. On wire nets with given spacing pipe grips are mounted (on the wire or crossing of wires) in which pipes are pushed. Spacing between pipe and insulation layer is 17 mm.

System KAN-therm NET can be successfully applied in order to fasten pipes to Tacker foamed polystyrene boards with metalized foil or laminated foil. In such cases do not use additional foil.



PE foil, dimension 2,0 m×50 m×0,8 mm

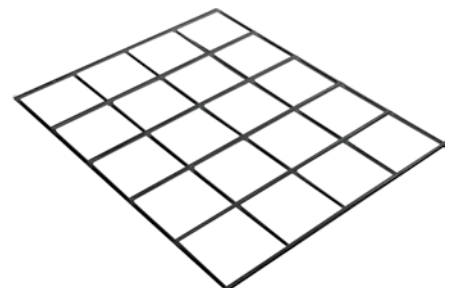

NET steel wire net is made of steel wire 3 mm thick, mesh size 150×150 mm



Fastening band for connecting NET nets



Peg for foil fastening size 80 mm - Ø8 mm



Grip for fastening pipes on NET Ø16-18 mm and Ø20 mm

Execution of floor screed

Prepared floor heating systems should be covered with a layer of concrete or anhydrite screed (wet). In the case of anhydrite screeds must comply with it's manufacturer's / supplier.

When making underfloor heating systems, observe the following guidelines:

- while laying screed keep pipes under pressure at least 3 bar (recommended 6 bar),
- pipes should be protected from mechanical damage during construction,
- determine passageways for example by using boards,
- screed needs to be nurtured,
- cement screed bonding period is 21-28 days, only after this period, you can run the heating,
- Installation start is carried out with an initial water temperature of 20°C, temperature should be raised about 5°C each day until it's value reaches designed level,
- after start-up periods screed should be basked min for 4 days with a maximum (designed) temperature to remove excess moisture,
- floor coverings should be laid at a temperature of 18-20°C of the floor, after screed is basked,
- pay attention to the proper implementation of joint of ceramic tiles (they should coincide with dilatation),
- adhesives should be permanently flexible at 55°C (hold manufacturers certificates for use in underfloor heating).

Requirements for concrete slab:

- minimum layer thickness over the pipe: 4.5 cm (6.5 cm thick over the thermal insulation),
- using concrete plasticizer BETOKAN Plus you can reduce the thickness of concrete slab above the pipe to 2.5 cm (4.5 cm thick over the thermal insulation),
- large casted areas should be divided into smaller with dilatation tape (with minimum thickness of 0.5 cm) so that the length of homogeneous plates do not exceed 8 m, the whole area of 30 m, and the ratio of the length of its width is 1:2,
- in case of ceramic tiles and ceilings carrying heavy loads, we recommended reinforcement by placing over the pipes fiberglass mesh with a mesh of 40×40 mm. Using reinforcement is not essential, however, the strength of the floor in the event of a crack is reduced in the height and width. Mesh must be stopped in the dilatation points. For floors carrying heavy loads (more than for residential buildings) such type of insulation and concrete slab height should be selected, so that the deflection does not exceed 5 mm,
- use B20 concrete class with the addition of a new plasticizer BETOKAN or BETOKAN Plus,
- concrete slab as a result of thermal work can not create pressure for structural elements of buildings (use dilatation joints).

The composition of cement to aggregate ratio is 1:4.5 parts by weight:

- 50 kg cement CEM I (DIN 1164),
- 225 kg of aggregate (60% sand with a grain size up to 4 mm and 40% gravel with a grain size of 4 - 8 mm), in case of use of BETOKAN plasticize:
 - 16 – 18 l of water,
 - 0,2 kg of BETOKAN,
 - Use 0.25 - 0.6% related to the cement mass (on average 200 ml for 50 kg of cement), together with batched water and aggregate. In hot weather it is recommended to double this dose to extend concrete workability.

— in case of use BETOKAN Plus plasticizer:

- 8 – 10 l of water,
- 5 kg of BETOKAN Plus,
- average consumption rate is: 10 kg per 7,5 m² of screed, at slab thickness 4,5 cm, which is 30 to 35 kg per 1 m³ of concrete.

Assembly

- 1 Deploy the wall edge tape.

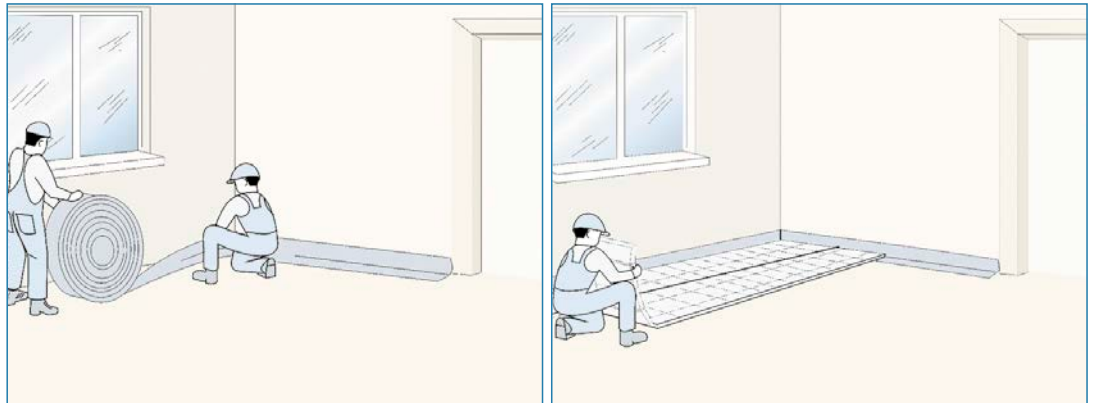

- 2 Spread the Styrofoam with PE-foil on top of it.

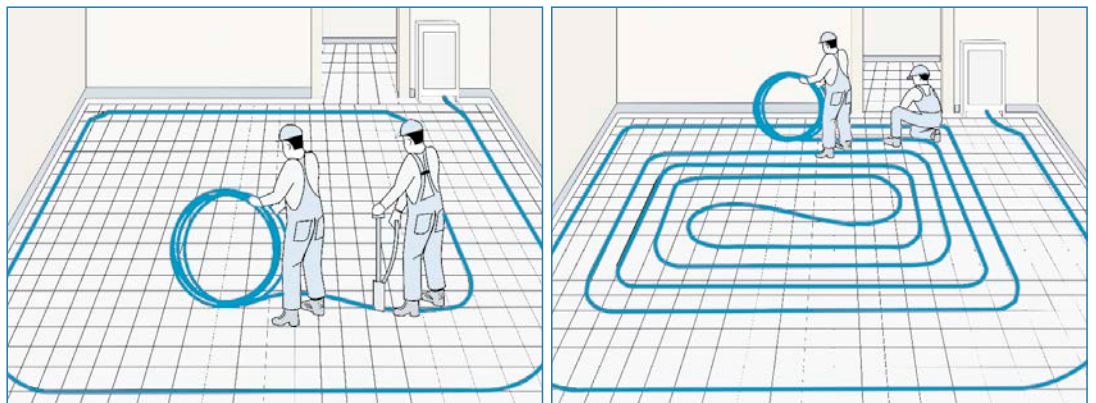

- 3 Connect the supply pipe to the manifold, lay at a required spacing (doubled), fasten pipes with clips at right places.

- 4 Lay the outlet pipe „backwards“ between the supply pipe coils.

For detailed information on the assembly of System KAN-therm floor heating and on the start-up of the system see: “Laying the System KAN-therm by the Wet Method”.

Construction of wall heaters - pipe fastening systems

Wet method

KAN-therm wall heating elements are ideal for the construction of various types of heating and cooling systems mounted on the vertical construction partitions. Having all the advantages of surface heating, KAN-therm water wall heating is further characterized by the following beneficial features:

- may function as the only independent room heating, or serve as a supplementary heating in the absence of sufficient space for underfloor heating in the room. It may also support the radiator heating, while increasing the comfort in the rooms (used for the modernization of the heated building),
- it ensures uniform, almost ideal temperature distribution in the room and as a result high thermal comfort.
- vertical partitions, due to the identical heat transfer coefficients both for heating and cooling, are ideal for dual systems (heating/cooling).
- heat transfer takes place primarily through favourable radiation (approx. 90%),
- the temperature of the heating surface may be higher than in the underfloor heating (35°C) resulting in a higher heat efficiency,
- approximate heat output 120-160 W/m² (provided the maximum wall temperature is not exceeded).
- due to the smaller thickness of the heating / cooling panel and a small (or zero) thermal resistance of the outer layers (cladding) of the walls, the thermal inertia is lower and the temperature adjustment becomes easier.

The main feature are special rail plastic strips for fastening pipes. You can use the following pipes: PB, PE-Xc, PE-RT and PE-RT/Al/PE-RT with the diameter Ø8×1, Ø12×2, Ø14×2, Ø16×2 mm. Pipes may be laid with a distance of 6-30 cm - in steps of 6 cm (diameter 8 × 1 mm) or 10-30 cm - with step of 5 cm for the remaining diameters.

1. Mounting rail for pipes of Ø8 mm.
2. Profiling curve D60 mm for pipes of Ø8 mm..

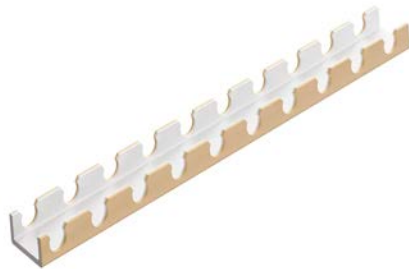

1. Mounting rail.
2. Modular mounting rail.



Wall heating is mounted on the external walls with a penetration coefficient of $U \leq 0.35 \text{ W/m}^2 \times \text{K}$. If the penetration coefficient exceeds 0.4 W/m^2 , the wall must be additionally insulated. It is recommended that installation be done near window openings, e.g. under the window sills. Heating may also be laid in the inner walls. You should use KAN-therm system pipes PB or PE-RT with the diameter of 8×1 , KAN-therm system pipes PE-Xc or PE-RT with the diameter of 12×2 , 14×2 i 16×2 and multilayer KAN-therm system pipes PE-RT/Al/PE-RT with the diameter of 14×2 and 16×2 . Recommended spacing between the pipes is 25 cm. Pipes should be installed with a meander pattern. In case of small spacing, pipes may be installed with a double meander pattern. The heating surfaces should be kept clear of furniture, paintings, curtains. Before laying the surface heaters you should first complete all installation and electrical works. The minimum distances between the heating pipes and the adjacent partitions and holes are presented in the following figure.

Mounting distances in wall heating

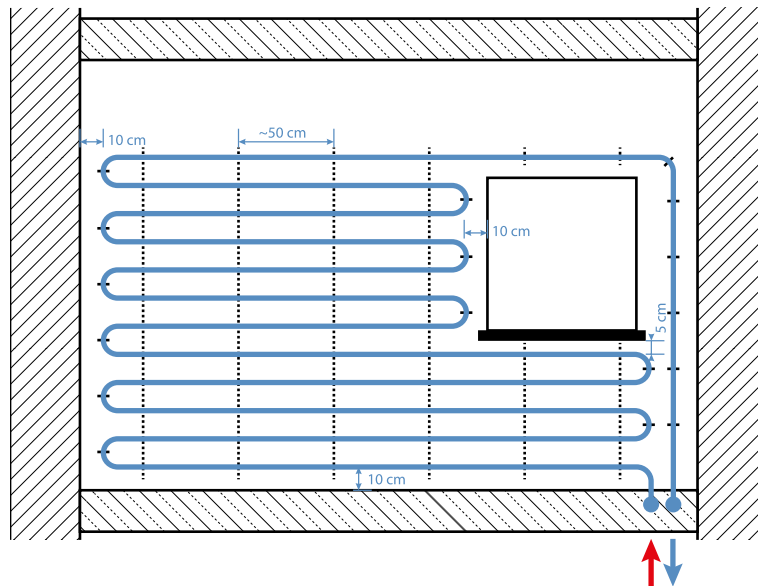

The contact points between the heating walls and adjacent partitions should be fitted with expansion joints. Coil supply pipes laid on the floor should be provided with insulation or protective tube. At the transition from the floor to the wall the pipe should be laid with a 90° guide. The heating loops are supplied by KAN-therm manifolds for surface heating. The coils may also be supplied with counter-current Tichelmann system, provided the length of each connected circuit is identical. To determine the position of the heating pipes in the existing wall systems you may use a thermal imaging camera or a special heat-sensitive film.

Installation of wall heating using wet method

Pipes should be mounted with KAN-therm Rail mounting rails which are fixed to the wall using dowels. The spacing between the mounting rails should not exceed 50 cm. The plaster layer of the heating plate should have good thermal conductivity (min. $0.37 \text{ W/m} \times \text{K}$), resistance to temperature (approx. 70°C for cement-lime plasters, 50°C for gypsum plasters), flexibility and low expansion coefficient. The type of plaster must be suitable for the room concerned. You may use cement-lime plasters, gypsum plasters, as well as clay mortars. Recommended finished plasters: e.g. KNAUF MP-75 G/F. The air temperature during plastering works should not be lower than 5°C . The plaster should be applied in steps: first layer with a thickness of approx. 20 mm should completely cover the heating pipes. The fresh layer must be covered with fibreglass mesh of $40 \times 40 \text{ mm}$, then apply the second layer with a thickness of 10 – 15 mm. The mesh strips should overlap each other and those of adjacent surfaces (approx. 10 – 20 cm). The maximum height of the heating field is 2 m. The surface of the field should not exceed 6 m^2 / heating circuit. During plastering the heating pipes should be filled with water under pressure (min. 1,5 bar). The heating-up stage should be started only after the plaster has dried (the time specified by the manufacturer of plaster - from 7 days for gypsum plasters, up to 21 for cement plasters). The plaster may be covered with paints, wallpaper, structural paints and ceramic tiles.

Dry method

The main feature are gypsum fibre boards with embedded polybutylene heating pipe $\text{Ø}8 \times 1$ mm. The boards are available in wide selection of dimensions, with coil spacing of 6,25 and 7,75 cm. The thickness of the board is 15 mm.

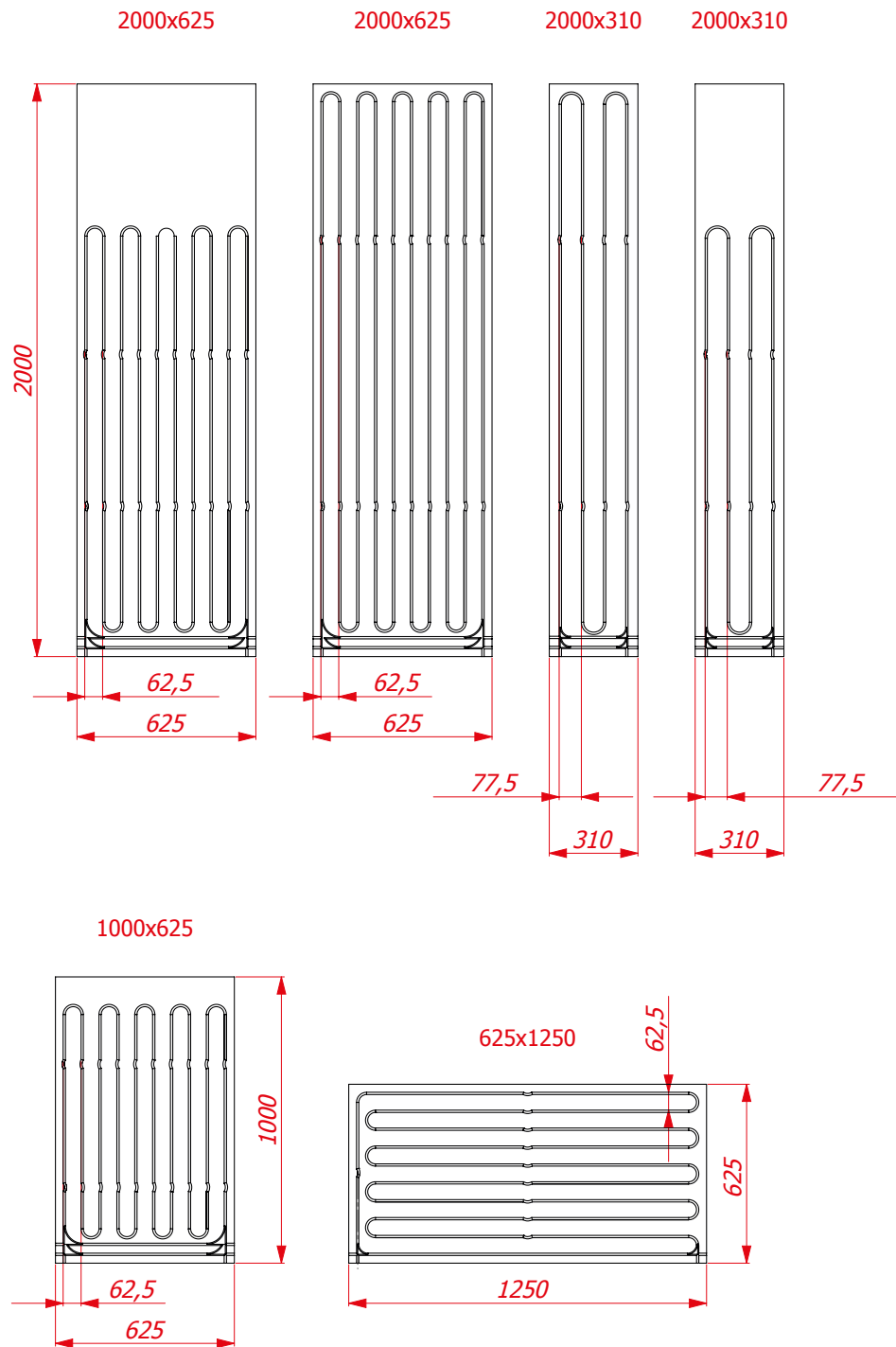

The boards are mounted on the external walls with a penetration coefficient of $U \leq 0.35 \text{ W/m}^2 \times \text{K}$. If the penetration coefficient exceeds 0.4 W/m^2 , the wall must be additionally insulated. Heating may also be laid in the inner walls. You should use polyurethane adhesives or appropriate screws / mounting dowels. The pipes may be connected in series or with counter-current Tichelmann system using multilayer pipes of $\text{Ø}16 \times 2 \text{ mm}$. This is done using special sections for toolless connection. You should not exceed the total length of a single loop 80 m.

1. Union for pipes $8 \times 1 \text{ G}3/4"$.
2. Click joint for pipes 8×1 .
3. Reduction joint
Press-Click 16 / 8
4. Tee with an off-take
Press-Click-Press16 / 8 / 16.



The heating surfaces should be kept clear of furniture, paintings, curtains. Before laying the surface heaters you should first complete all installation and electrical works.

The contact points of the board should be filled with plaster, whereas the contact points between the heating walls and adjacent partitions should be fitted with expansion joints. Coil supply pipes laid on the floor should be provided with insulation or protective tube. At the transition from the floor to the wall the pipe should be laid with a 90° guide. The heating loops are supplied by KANtherm manifolds for surface heating. To determine the position of the heating pipes in the existing wall systems you may use a thermal imaging camera or a special heat-sensitive film. The boards may be covered with plaster, paints, wallpaper, structural paints and ceramic tiles.

Automatic control of heating/cooling systems

Presently the automatic control even the most simple one counts as an indispensable element of heating systems (mounted in single family houses, blocks of apartments, public houses and industrial buildings) and as well of all types of external surface heating.

Diversity of technical solutions for the heating technology and in first line solutions of very commonly used mixed heating systems, e.g. a surface heating combined with a conventional radiator heating, despite many advantages, without proper control elements, can lead to a substantial discomfort. Usually overheating, underheating or not a uniform temperature in individual spaces causes this discomfort.

Without a correctly configured automatic control controlling individual heating systems can cause significant heat losses (overheated rooms), therefore an increase in the operation cost of a heating system.

System KAN-therm offer of surface heating automatic control allows to optimise a heating system depending on local requirements by selection of appropriate devices, elements etc.

Automation components for radiant heating KAN-therm System come in three versions:

- terminal blocks and thermostats – version Basic,
- terminal blocks and thermostats – version Basic+,
- Terminal blocks with LAN module, room thermostats and servomotors SMART.



Terminal blocks Basic

With the Basic 230V or 24V terminal block as a version with or without a pump module – you can connect thermostats and servomotors at one place (e.g. in an installation cabinet above a manifold). It is possible to connect max. 6 thermostats and 12 servomotors.



Terminal block with pump module, enables to connect the circulation pump 73 and 77 series manifolds and pump groups.

Terminal block has a heating function.

The pump module – stops a pump in case all floor heating servomotors are shut down by a thermostat because a required temperature in a room has been reached. A pump is restarted when at least one servomotor opens.

24V terminal blocks are delivered without a power converter.

The Basic terminal block for heating and cooling, with pump module in 230V and 24V version.



Terminal block enables connection of thermostats and servomotors in one place (e.g. in a cabinet over the manifold). It is possible to connect max. 6 thermostats and 12 servomotors.

As a standard function a terminal block heats, however, by using special thermostats it can cool.

Both versions (230V and 24V) may be equipped with a pump module.

The 230 V terminal blocks are delivered without a power cord and the 24V version without a power converter.

Room thermostats Basic



Electronic, room thermostat Basic with a diode, 230 or 24V

– for an individual temperature control in a room. A LED under the thermostat housing signals the operation status of the heating installation – when ON, the system is active.



Electronic, room thermostat Basic – for heating and cooling, 230 or 24V

– for an individual temperature control in a room. It may operate in heating and cooling installations thanks to Basic heating / cooling terminal block.

Week thermostats Basic



230V weekly thermostat with floor sensor - allows for individual adjustment of temperature in the room. The thermostat has the function of weekly programming. It is equipped with a floor temperature sensor. The thermostat has the option of a manual and automatic control. It may cooperate with Basic and Basic+ terminal blocks in 230V version.



The 230V or 24V weekly thermostat - allows for individual adjustment of temperature in the room. The thermostat has the function of weekly programming. The thermostat allows for temperature adjustment in manual and automatic mode. It is possible to link the thermostat with the Basic 230V or 24V terminal block. Two AA batteries are required.

The additional elements Basic



230V - 24V Voltage transformer for Basic/Basic+ electrical strip - compensating element for the Basic terminal block in 24V version.



An M28 x 1,5 Smart adapter for electric servomotors (grey) – used for valves on the upper beam of 71A, 75A, 73E, 77E.



An M30 x 1,5 adapter for electric servomotors (grey) – used for thermostatic valves e.g. on the manifold supply with a mixing system 73E, 77E and for valves on the upper beam of manifolds N75A and N75E.



KAN-therm servomotor - 230V or 24V version "First Open" function for easy installation of the servomotor and pressure test. NO or NC operating mode versions. Quick installation with KAN-therm M28x1.5 or M30x1.5 adapters. Solid mounting with three-point locking system. Servomotor calibration - automatic alignment to the valve. Visualization of the servomotor operating status. Servomotor assembly in any position. 100% protection against water and moisture. Energy efficiency - power consumption of only 1W.

Basic+ automation



Basic+ automation - a set of devices for wired, precise temperature control in rooms. Basic+ is the ideal solution for both simple and complex heating or cooling systems. Its modern design perfectly blends with the various interior arrangements.

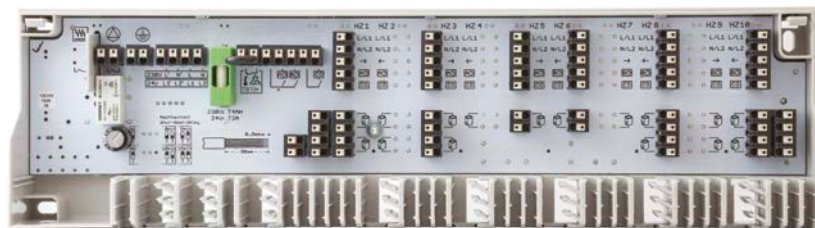

Basic+ terminal blocks provide power for all control elements. Available with heating - cooling version with possibility to control 6 or 10 heating zones. Both versions are available in 230V and 24V version (required 230/24 V AC transformer). Terminal blocks can control the boiler and circulation pump operation. In addition the automatic mode can be set to work with Normally Closed or Normally Open servomotors.

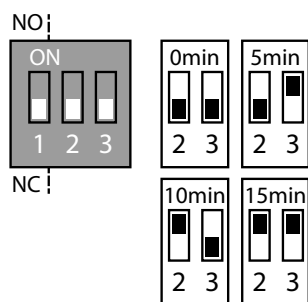

The operation mode setting is carried out using Jumper 1:

NO mode: Jumper 1 = ON

NC mode: Jumper 1 = OFF

The constant overtravel time of the pump or boiler of 2 min may be increased by a further 5, 10 or 15 minutes using Jumper 2 and 3:

Additional time	Jumper 2	Jumper 3
0 min	OFF	OFF
5 min	OFF	ON
10 min	ON	OFF
15 min	ON	ON

Terminal block Basic+	24V	230V
Ground connector		+
Pump / boiler power outlets (230 V)		+
Dew point sensor connector (24 V)	+	
Selectable pump / boiler switch delay	+	+
Direct operation pump module		+
Temperature limiter connector	+	+
External timer connection	+	+
Heating / cooling change over (CO)	+	+
Servomotor type (NC or NO)	selectable	selectable
LED indicators	+	+
Number of heating zones	6 or 10	6 or 10

Basic+ thermostats

1. Analogue room thermostat.
2. Room thermostat with LCD Standard.
3. Room thermostat with LCD Control.



Funktionalität	Analogue room thermostat		Thermostat with LCD	
	Heating	Heating / Cooling	Standard	Control
Operation in heating systems	1802265024 1802265025	1802265032 1802265033	1802265020 1802265021	1802012005 1802012004
Operation in cooling systems	+	+	+	+
NC and NO servomotors operation				+
Constant value night temperature setback	+	+	+	
Variable temperature set-point for both: heating and cooling operation				+

Funktionalität	Analogue room thermostat		Thermostat with LCD	
	Heating 1802265024 1802265025	Heating / Cooling 1802265032 1802265033	Standard 1802265020 1802265021	Control 1802012005 1802012004
User comfort programs				+
Variable mode: Day / Night / Auto			+	+
Temperature reduction signal input	+	+	+	
Temperature reduction signal output				+
Internal timer				+
Voltage sustain				+
Change Over (CO) connector		+		+
Temperature measurement correction			+	+
Temperature settings limiter	+	+	+	+
Valve protection function		+	+	+
Protection against system freezing	+	+	+	+
Lock against operation in heating or cooling mode				+
Smart Start / Smart Stop function				+
Floor temperature sensor connector				+

Additional elements Basic+



**230V - 24V power converter for Basic/
Basic+ terminal block**



M28 × 1.5 Smart Adapter for the electric servomotor
(gray) - used for valves on the upper beam of 71A, 75A, 73E, 77E manifolds.



M30 × 1.5 Adapter for the electric servomotor
(gray) - used for thermostatic expansion valves, e.g. on the manifold with the mixer motor series 73E, 77E and to the valve on the top beam N75A and N75E.



KAN-therm servomotor - 230V or 24V version "First Open" function for easy installation of the servomotor and pressure test. NO or NC operating mode versions. Quick installation with KAN-therm M28x1.5 or M30x1.5 adapters. Solid mounting with three-point locking system. Servomotor calibration - automatic alignment to the valve. Visualization of the servomotor operating status. Servomotor assembly in any position. 100% protection against water and moisture. Energy efficiency - power consumption of only 1W.

SMART automatics

Smart and intelligent - new KAN-therm Smart wireless automatics system

A comfortable and energy efficient home is the goal and the dream of today's families planning to build or modernize their houses and apartments. The method of heating is one of the most important factors determining the operating costs and the sense of security and comfort of use. Surface heating (floor or wall) is the optimal solution that assures meeting such requirements. However, like any heating system, it requires a proper control system. Precise devices regulating the temperature in the room provide an adequate thermal comfort and on the other hand allow for significant energy savings. The regulation can be done manually or in the automatic mode, with the use of the appropriate sensors, regulators and servomotors.

The requirements of the users are constantly increasing. They are expecting not only the reliability and effective operation of these devices but also hassle-free, easy operation and the possibility of varied configuration, including remote configuration using mobile devices such as a laptop or a smartphone. The attractive aesthetics of these devices and the possibility to expand the system in the future are also of great significance.

KAN-therm radiant heating and cooling offer includes a wide range of modern solutions like controlling devices and automatic regulation of the temperature. This also includes technologically advanced wireless devices communicating through the radio waves, greatly simplifying installation of the heating system controls and eliminating the problems and costs associated with distributing many meters of wires in the building. They are virtually indispensable in the case of retrofitting existing modernized installations with automatics.



Devices of the KAN-therm Smart System are a completely new generation in this group of automation elements, offering unprecedented operating and handling possibilities. They are used for the wireless control and regulation of temperature and other parameters of the heating and cooling systems, which determine the sense of comfort in the rooms. The System also provides a number of additional advanced features, which make the operation and handling of the heating system very effective, energy efficient and user-friendly.

Basic component and the heart of KAN-therm Smart System is the modern wireless terminal block with an LAN connection. Using radio communication (868 MHz, two-way transmission) it communicates with the wireless, elegant thermostats with LCD display, which function both as temperature sensors in the rooms and are also displaying and transmitting a number of settings and information controlling the entire system. This information is transmitted, through the terminal block, to the executive elements - modern, energy-efficient KAN-therm Smart servomotors located on the valves of the manifolds of the heating (or cooling) circuits. The terminal blocks and servomotors are available in the 230 and 24V power supply options. Depending on the used version, the terminal block can operate 4, 8 or 12 thermostats controlling respectively 6, 12 or 18 servomotors.

The KAN-therm Smart system is a multi-functional system which in addition to controlling and regulating the temperature in various heating zones, also realizes the switching between heating / cooling modes, the control of the heat source and operation of the pump as well as control of humidity in the cooling mode. The terminal blocks also enable connecting a temperature limiter and an external control timer. Functions such as protection of the pump and valves (activated after periods of extended downtime) and protection from frost and excessive critical temperature are also realized.

Measure of the system's high technological advancement is the method of installation and configuration. These operations can be done in several ways:

- Configuration using a microSD card. Using the computer and the intuitive KAN-therm Manager program we can determine individual configuration settings, which are then transferred using a microSD card to the terminal block equipped with a card reader.
- Remote configuration of the terminal block connected directly to the Internet or the local network through the KAN-therm Manager software interface.
- Direct configuration thanks to KAN-therm Smart thermostat (with the use of the LCD display).

In any case, the configuration and operation of the system is user friendly. Many processes take place automatically and the settings both with thermostat or the KAN-therm Manager program are very intuitive. The expansion of the system and a quick update of the terminal block settings does not cause any trouble either.

Thanks to the radio technique, in the case of bigger installations, with the use of 2 or 3 KANtherm Smart terminal blocks, it is possible to combine them into one system enabling mutual communication.



KAN-therm Smart wireless terminal blocks with LAN connection



- Two-way 868 MHz wireless technology,
- 230V or 24V (with a power converter),
- The possibility of connecting up to 12 thermostats and up to 18 servomotors,
- Heating and cooling modes as a standard,
- Pump protection and manifold valves protection functions, frost protection function, safety temperature limiter, emergency mode,
- Operating modes of the servomotors: NC (normally closed) or NO (normally open),
- MicroSD card reader,
- RJ 45 Ethernet socket (for connecting to the Internet),
- The ability to connect additional devices: pump module, dew point sensor, external timer, additional heat source controller,
- Clear visualization of the operating status with LED indicators,
- 25 m range inside buildings,
- Start „SMART“ function – the ability to run an automatic adjustment of the system to the conditions in the room / building,
- Configuration using a microSD card, through the software interface of the network version or by the wireless thermostat,
- The possibility of easy and simple expansion of the system and quick updating of settings (through the network or the microSD card).

Wireless LCD thermostat KAN-therm Smart



- Modern and elegant design, high quality scratch-resistant material,
- Small size of the device 85 x 85 x 22 mm,
- Large (60 × 40 mm) clear LCD display with a backlight,
- Communication System based on pictograms and a rotary knob ensure intuitive and easy operation,
- Very low energy consumption - over two years battery lifetime,
- Possibility of connecting a floor temperature sensor,
- Two-way radio data transmission within a range of 25 m,
- Comfortable and safe use guaranteed by a three-level MENU layout: user functions, parameters of user settings, installer settings (service),
- Many useful features such as: child safety lock, standby mode, modes of operation day / night or auto, „Party“, „Vacation“ features,
- A number of possible parameter settings - temperature (heating / cooling, temperature drop), timer, programs.

KAN-therm Smart Servomotors



- 230V or 24V Version,
- „First Open“ feature facilitating installation of the servomotor and the performance of the pressure test,
- NC or NO operating mode versions,
- Fast installation with the use of M28×1,5 or M 30×1,5 KAN-therm adapters,
- Reliable mounting with a three-point locking system,
- Calibration of the servomotor – automatic adjustment to the valve,

- Visualization of the operating mode of the servomotor,
- Installation of the servomotor in any position,
- 100% protection against water and moisture,
- Energy efficiency - only 1W power consumption.

Automation additional elements



External surface ice controller with the external temperature and icing sensor - in cooperation with the heating system it protects against icing and snow depositing on stairs, parking lots, driveways, etc.



The snow and ice sensor, as well as the external temperature sensor is assembled with a 15 m electric wire.